



Digital Wireless System
RS 160

Instruction manual



Contents

Important safety information	2
The RS 160 digital RF headphone system	4
Delivery includes	5
Product overview	6
Overview of the HDR 160 headphones	6
Overview of the TR 160 transmitter	7
Overview of the indicators and acoustic signals	8
Overview of the connection stages	10
Putting the RS 160 into operation	11
Setting up the transmitter	11
Connecting the transmitter to a sound source	12
Powering the transmitter	13
Powering the headphones	15
Adjusting the headband of the headphones	17
Using the RS 160	18
Switching the transmitter on and off	18
Switching the headphones on and off	20
Adjusting the volume on the headphones	21
Adjusting the signal of the sound source	22
Associating the headphones to the transmitter	23
Listening with several headphones simultaneously	26
Cleaning the RS 160	27
If a problem occurs	28
Accessories and spare part	30
Specifications	31
Manufacturer declarations	32

Important safety information

- Please read this instruction manual carefully and completely before using the product.
- Make this instruction manual easily accessible to all users at all times. Always include this instruction manual when passing the product on to third parties.
- Do not use the product in situations which require special attention (e.g. in traffic or when performing skilled jobs).
- Always keep the product dry and do not expose it to extreme temperatures (normal operating temperatures: 0 °C/32 °F to 40 °C/104 °F).
- Use the product with care and store it in a clean, dust-free environment.
- Switch the headphones off after use to conserve battery power. Remove the batteries if the product will not be used for extended periods of time.
- The headphones contain magnets that generate a magnetic field which could cause interference with cardiac pacemakers and implanted defibrillators. Keep the headphones at least 1.2" (3 cm) from cardiac pacemakers or implanted defibrillators.
- Please protect your hearing from high volume levels. Sennheiser headphones also sound exceptionally good at low volumes.
- Only use the Sennheiser supplied power supply units.
- To reduce the risk of fire or electric shock, do not use the product near water and do not expose it to rain or moisture.
- Unplug the power supply unit from the wall socket
 - to completely disconnect the product from the mains
 - during lightning storms or
 - when unused for long periods of time.
- Only operate the power supply unit from the type of power source specified in the chapter "Specifications" (see page 31).
- Ensure that the power supply unit is
 - in a safe operating condition and easily accessible,
 - properly plugged into the wall socket,
 - only operated within the permissible temperature range,
 - not covered or exposed to direct sunlight for longer periods of time in order to prevent heat accumulation (see "Specifications" on page 31).
- Do not operate the product near any heat sources.
- Only use attachments/accessories specified by Sennheiser (see "Accessories and spare part" on page 30).

Replacement parts

When replacement parts are required, be sure the service technician uses replacement parts specified by Sennheiser or those having the same characteristics as the original part. Unauthorized substitutions may result in fire, electric shock, or other hazards.

Intended use

Intended use of the product includes

- having read this instruction manual, especially the chapter “Important safety instructions” on page 2,
- using the product within the operating conditions and limitations described in this instruction manual.

“Improper use” means using the product other than as described in this instruction manual, or under operating conditions which differ from those described herein.















Safety instructions for the NiMH rechargeable batteries

If abused or misused, the rechargeable batteries may leak. In extreme cases, they may even present



- a heat hazard,
- a fire hazard,
- an explosion hazard,
- a smoke or gas hazard.

Please understand that Sennheiser does not accept liability for damage arising from abuse or misuse.

	Keep away from children.		Only use rechargeable batteries recommended by Sennheiser.
	Observe correct polarity.		Do not short-circuit.
	Do not expose to moisture.		Switch rechargeable battery-powered products off after use.
	Do not pack charged batteries loose – danger of shorting out/fire hazard.		When not using rechargeable batteries for extended periods of time, charge them regularly (about every 3 months).
	Only charge rechargeable batteries at ambient temperatures between 10 °C/50 °F and 40 °C/104 °F.		Do not heat above 70 °C/158 °F, e.g. do not expose to sunlight or throw into a fire.
	Do not mutilate or dismantle.		Do not continue to use defective rechargeable batteries.
	Immediately remove rechargeable batteries from obviously defective devices.		Dispose of rechargeable batteries at special collection points or return it to your specialist dealer.

The RS 160 digital RF headphone system

The RS 160 is an RF stereo hi-fi headphone system with comprehensive technical features. Its transparent and balanced sound image with excellent bass response makes this system an ideal choice for hi-fi, home cinema and TV use.

Enjoy total freedom of sound, stylish design and maximum comfort.

Additional features of the RS 160 headphone system

- Transmits uncompressed audio over a robust 2.4 GHz digital link, enabling you to enjoy your music without the hassles of cables.
- Dynamic transducer systems with powerful neodymium magnets deliver clear and detailed audio reproduction.
- Kleer's uncompressed digital wireless transmission delivers CD-quality sound.
- No set-up required – just plug and play. Simply connect the transmitter to your personal audio/video player, put on the headphones and turn it on!
- TR 160 transmitter with multi-receiver capability, enabling up to 4 people to listen to the same sound source.

Kleer™ wireless transmission technology



The RS 160 headphone system features the digital wireless audio transmission technology from Kleer. The Kleer company has developed an RF-based wireless transmission standard (of the same name) that offers lossless audio transmission in CD-quality while consuming minimal power.

Delivery includes

- 1 HDR 160 headphones
- 1 TR 160 transmitter
- 1 power supply unit with country adapters
- 1 stereo audio cable with 3.5 mm jack plugs
- 1 DC cable (4.0 mm DC jack socket to 2 x 4.0 mm DC plug)
- 2 AAA size NiMH rechargeable batteries, 1.2 V
- 1 quick guide incl. CD ROM with detailed instruction manual (PDF file)
- 1 safety guide

Product overview

Overview of the HDR 160 headphones



- ① Headband
- ② Ear pads
- ③ Battery compartments

- ④ VOLUME + button
- ⑤ Multi-function button 
- ⑥ VOLUME - button
- ⑦ Charging socket (DC 5V 0.5A)
- ⑧ Multi-function LED



With the multi-function button  ⑤, you can switch the headphones on/to standby mode, set the headphones to multi-user operation, mute the headphones and associate the headphones.

Overview of the TR 160 transmitter

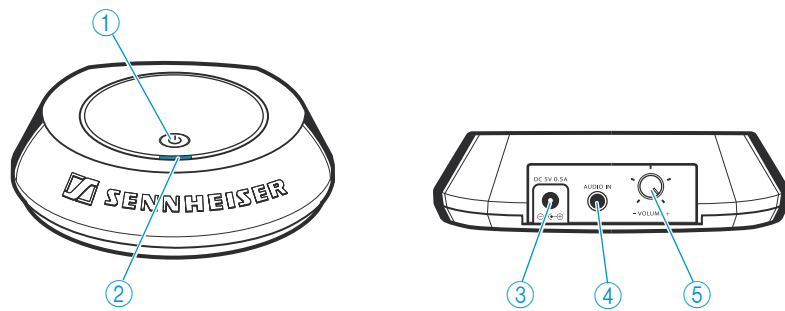

- ① Multi-function button 
- ② Multi-function LED
- ③ Socket for power supply unit (DC 5V 0.5A)
- ④ Audio input (AUDIO IN)
- ⑤ VOLUME control (- +)







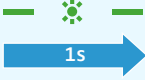
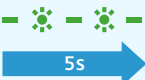

With the multi-function button  ①, you can switch the transmitter on/to standby mode, set the transmitter to multi-user operation and associate the transmitter.

Overview of the indicators and acoustic signals



Meaning of the pictograms for the different LEDs

Status	Meaning
	The LED is lit.
	The LED flashes once per second.
	The LED flashes twice every 5 seconds.

Indicators on the headphones

Indicator	Status	Meaning
Multi-function LED 		The rechargeable batteries are almost flat.
		The rechargeable batteries are being charged.
	off	The rechargeable batteries are fully charged.
		The headphones are in enrollment mode (searching for a transmitter to pair with).
		The headphones are in association mode (exchanging device information with the transmitter).
		The headphones receive an audio signal.

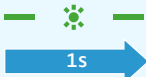
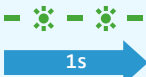
Indicators on the transmitter

Indicator	Status	Meaning
Multi-function LED ②		The signal of the sound source is too strong.
		The transmitter is in enrollment mode (searching for headphones to pair with).
		The transmitter is in association mode (exchanging device information with the headphones).
		The transmitter is in single-user operation.
		The transmitter is in multi-user operation.

Acoustic signal of the headphones

1 short beep	Meaning
	The minimum volume is reached.
	The maximum volume is reached.

Overview of the connection stages

Connection establishment

Enrollment mode

When you switch the headphones and the transmitter on, the headphones search for a suitable transmitter.

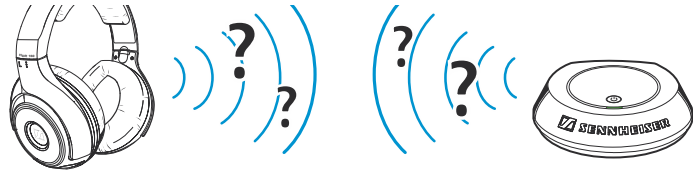
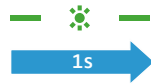

Pairing

The headphones and the transmitter have recognized each other and the headphones are paired with the transmitter.

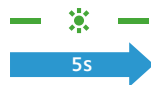

Single-user and multi-user operation

Single-user operation

You can listen to your sound source via one pair of headphones. By default, the transmitter is set to single-user operation (see page 23).

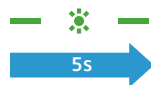

Multi-user operation

In order to be able to listen to your sound source with several headphones simultaneously, you have to set your transmitter to multi-user operation (see page 26).



Putting the RS 160 into operation

Setting up the transmitter

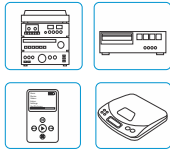

- ▶ Choose a suitable place near your sound source (e.g. TV, stereo or home cinema system).
- ▶ Do not place the transmitter close to metal objects such as shelf bars, reinforced concrete walls, etc. as this can decrease the transmitter's range.
- ▶ Make sure that there is direct line of sight between the transmitter and the headphones.

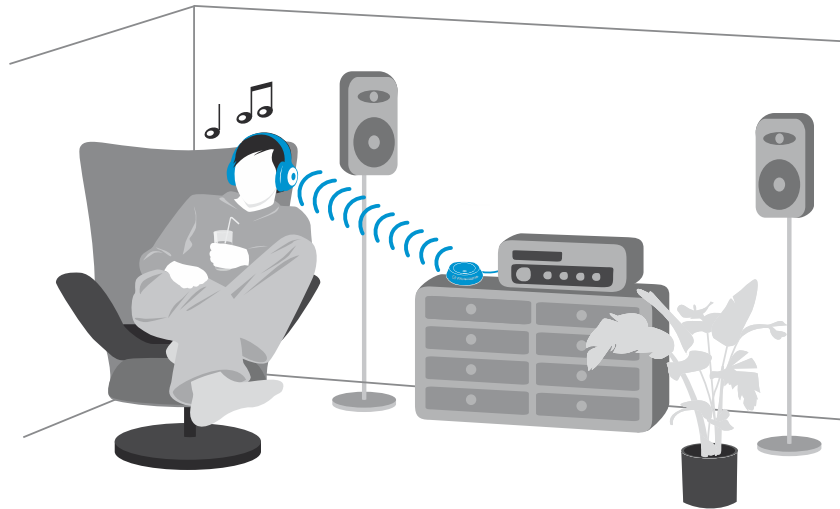

Connecting the transmitter to a sound source

You can connect the TR 160 transmitter to different sound sources, such as a TV, a DVD player or a stereo system.

- ▶ Switch your sound source off before connecting the transmitter.

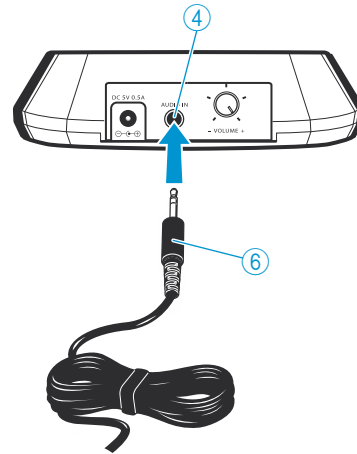

- ▶ Connect the audio cable ⑥ to the audio input ④ of the transmitter.
- ▶ Connect the audio cable ⑥ to the headphone socket of your sound source.

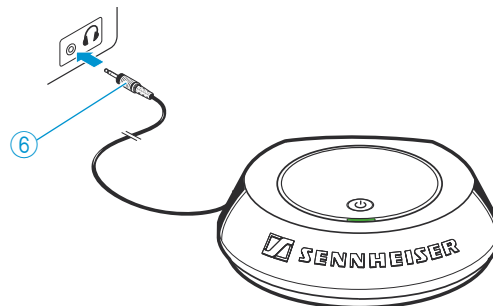

- ▶ Adjust the volume on your sound source to a medium level. This improves the quality of wireless sound transmission. If necessary, check the settings of your sound source.

Powering the transmitter

For powering the TR 160 transmitter, you can use:

- the supplied SSA-4P 5050F power supply unit for stationary use
- rechargeable batteries (AA size, NiMH, 1.2 V, at least 1,300 mAh) for mobile use
- standard batteries (AA size, 1.5 V) for mobile use

Powering the transmitter via the power supply unit

- ▶ Select the suitable country adapter ⑧ for your wall socket.
- ▶ Slide the country adapter ⑧ onto the power supply unit ⑦ until it locks into place.

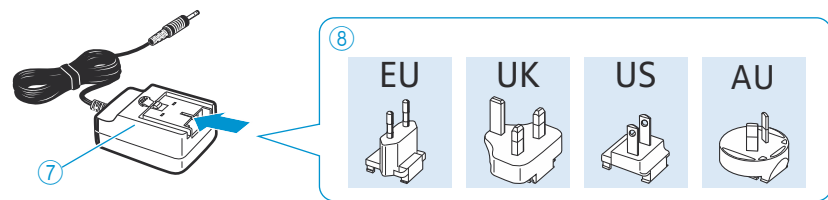

- ▶ Connect the connector ⑨ of the power supply unit to the socket ③.

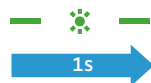
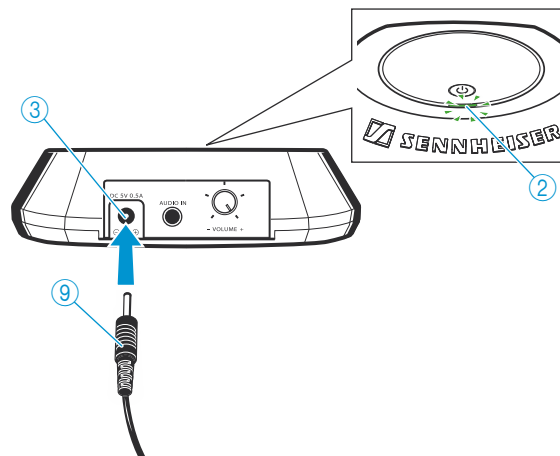

- ▶ Plug the power supply unit ⑦ into a wall socket. The transmitter switches on. The multi-function LED ② flashes green after 9 seconds. The transmitter is in enrollment mode.

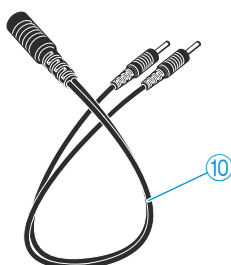

- ▶ You can also connect the charging cable ⑩ to the connector ⑨ of the power supply unit to conveniently charge your headphones (see "Charging rechargeable batteries in the headphones" on page 16).

Inserting rechargeable batteries/standard batteries into the transmitter and changing them

- ▶ Power the TR 160 transmitter either with rechargeable batteries (AA size, NiMH, 1.2 V at least 1,300 mAh) or standard batteries (AA size, 1.5 V).
- ▶ Open the battery compartment at the base of the transmitter as shown.
- ▶ Remove the depleted rechargeable batteries or batteries (where applies).
- ▶ Insert the rechargeable batteries or batteries. Observe correct polarity.

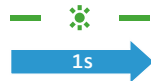
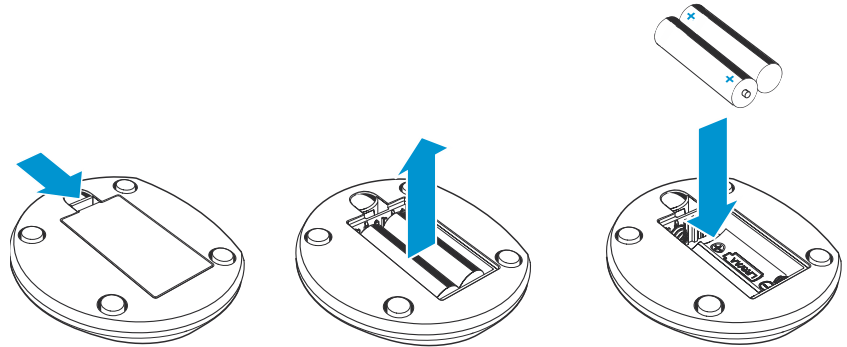

- ▶ Close the battery compartment.
The cover locks into place with an audible click and the transmitter switches on. The multi-function LED ② flashes green after 9 seconds. The transmitter is in enrollment mode.

Powering the headphones

For powering the headphones, you can use:

- standard batteries (AAA size, 1.5 V)
- rechargeable batteries (AAA size, NiMH, 1.2 V, 600 mAh)

If you use rechargeable batteries, you can charge them in the headphones using the charging cable ⑩ (see next chapter).

Inserting rechargeable batteries/standard batteries into the headphones and changing the rechargeable batteries/standard batteries



- ▶ Remove the ear pads ② from both ear cups by turning the ear pads in the direction of the arrow until you overcome a slight resistance.
- ▶ Lift the ear pads ② off the ear cups.

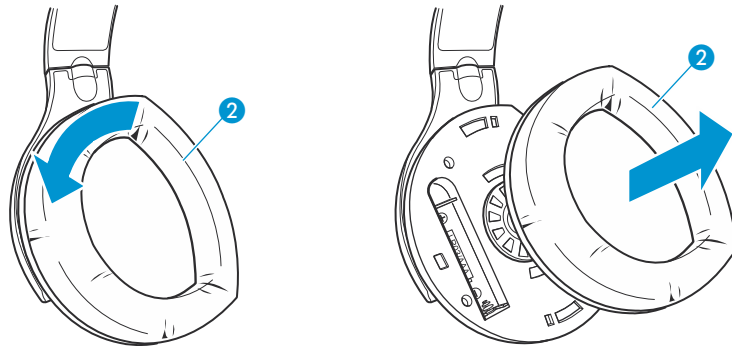

- ▶ Remove the depleted rechargeable batteries or batteries (where applies).
- ▶ Insert the rechargeable batteries or batteries. Observe correct polarity.

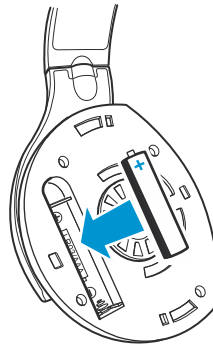

- ▶ Secure the ear pads ② to the ear cups.

Charging rechargeable batteries in the headphones

CAUTION Danger of damage to the headphones!

If standard batteries are inserted into the headphones, the batteries can leak during charging and damage the headphones.

- ▶ Only charge rechargeable batteries in your headphones.



Charge the rechargeable batteries for at least 16 hours prior to first time use. Subsequent charging time is about half of the previous operating time. The operating time is up to 24 hours.

- ▶ Connect the charging cable ⑩ to the charging socket ⑦ on the headphones.
- ▶ Connect the charging cable ⑩ to the socket ③ on the transmitter.
- ▶ Connect the charging cable ⑩ to the connector ⑨ of the power supply unit.
- ▶ Plug the power supply unit ⑦ into a wall socket.
The rechargeable batteries are being charged. The multi-function LED ⑧ on the headphones lights up orange.

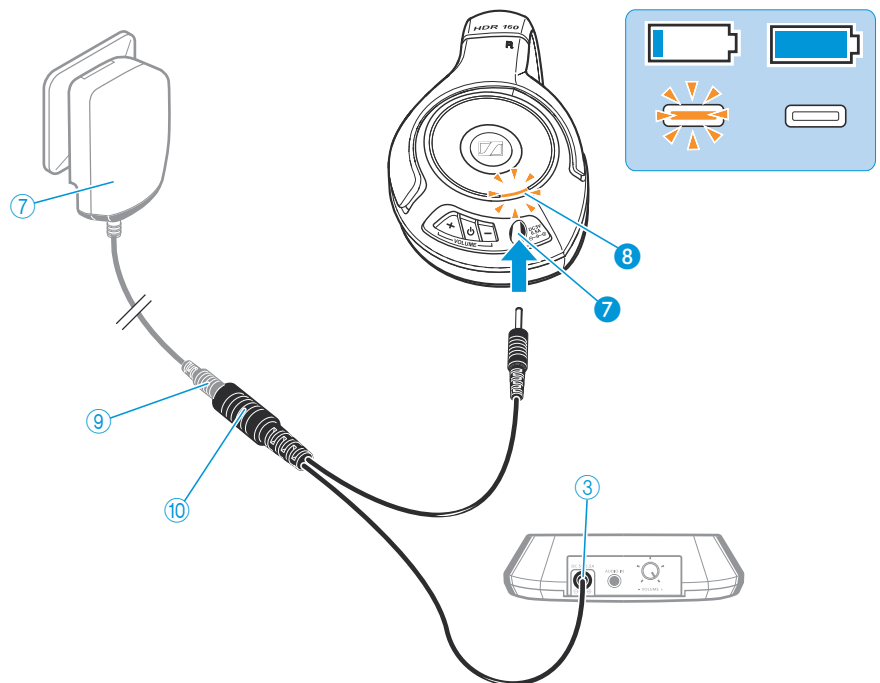

The transmitter automatically switches from battery operation to mains operation if you connect the power supply unit or the charging cable ⑩ to the transmitter.

Adjusting the headband of the headphones

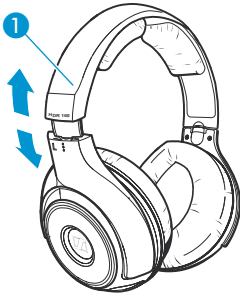

For good sound quality and best possible comfort, the headband has to be adjusted to properly fit your head. To do so, adjust the headband ① via its snap-in locking mechanism:

- ▶ Wear the headphones so that the headband ① runs over the top of your head.
- ▶ Adjust the length of the headband so that
 - your ears are completely inside the earpads,
 - you feel even, gentle pressure around your ears,
 - a snug fit of the headband ① on the head is ensured.

Using the RS 160

To switch the product on and to listen to your sound source, proceed as follows:

Sequence of steps	Page
1. Make sure that the rechargeable batteries are charged.	16
2. Switch your sound source on.	–
3. Switch your transmitter on.	18
4. Switch your headphones on.	20
5. Adjust the desired volume.	21

Switching the transmitter on and off

Switching the transmitter on

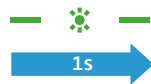

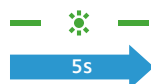

- ▶ Press the multi-function button ① for approx. 1 second. The transmitter switches on. The multi-function LED ② flashes green, indicating that the transmitter is in enrollment mode.

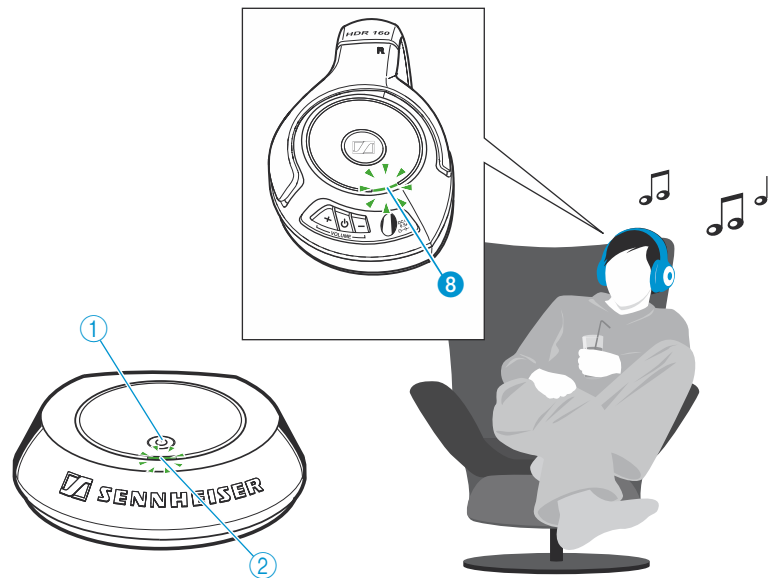

Once the transmitter has found suitable headphones, it pairs with the headphones and transmits an audio signal. The multi-function LED ⑧ of the headphones and the multi-function LED ② of the transmitter flash slowly.



Switching the transmitter off

- ▶ Press the multi-function button  ① for approx. 1 second.
The multi-function LED  ② goes off. The transmitter is in standby mode.

To disconnect the transmitter from the mains:

- ▶ Pull out the mains plug from the wall socket.



If the headphones are outside the transmission range or switched off for more than 5 minutes, the transmitter automatically switches to standby mode. The multi-function LED  ② goes off. In standby mode, the transmitter's power consumption is very low so that it can remain connected to the mains.

Switching the headphones on and off

WARNING Danger due to high volumes!



Listening at high volume levels for long periods can lead to permanent hearing defects.

- ▶ Before putting the headphones on, set the volume to a low level.
- ▶ Do not continuously expose yourself to high volumes.

Switching the headphones on

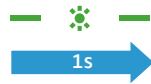

- ▶ Press the multi-function button  **5** for approx. 1 second. The headphones switch on. The multi-function LED **8** flashes green, indicating that the headphones are in enrollment mode.

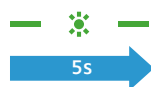

Once the headphones have found a suitable transmitter, the transmitter pairs with the headphones and transmits an audio signal. The multi-function LED **8** of the headphones and the multi-function LED **2** of the transmitter flash slowly.

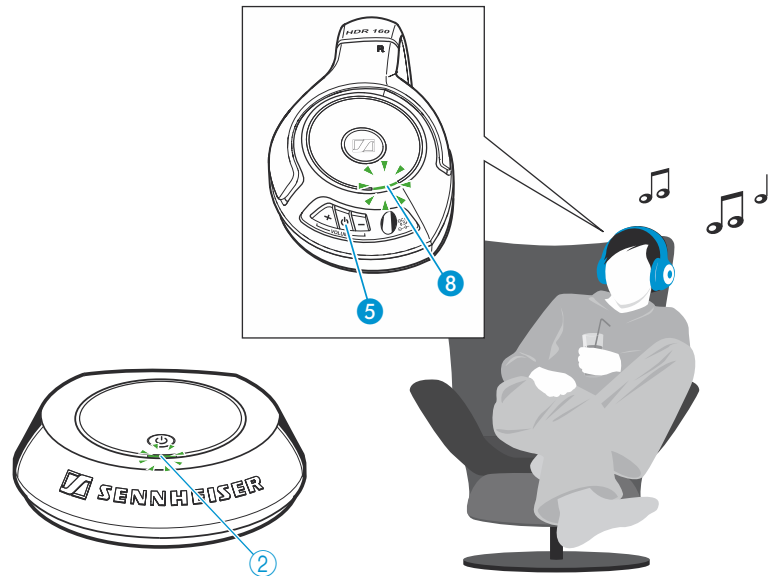

Switching the headphones off

- ▶ Press the multi-function button  **5** for approx. 1 second. The multi-function LED **8** goes off. The headphones are in standby mode.



If there is no signal from the transmitter for more than 5 minutes, the headphones automatically switch to standby mode.

Adjusting the volume on the headphones

- ▶ Press the **VOLUME –** button **6** or the **VOLUME +** button **4** repeatedly until the volume is adjusted to a comfortable and undistorted level.

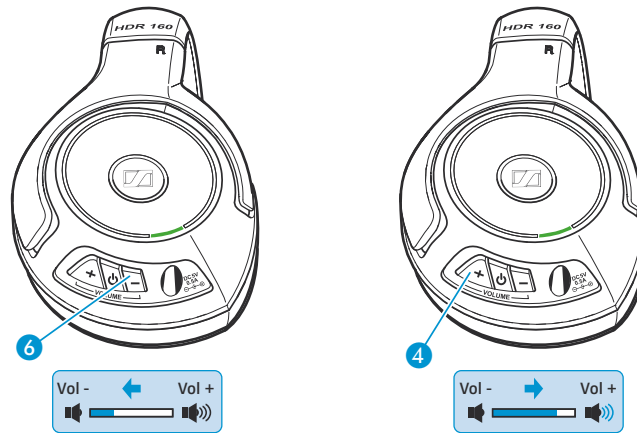

Muting the headphones

- ▶ Briefly press the multi-function button **5** to mute the headphones or to cancel the muting.



Adjusting the signal of the sound source

The transmitter automatically ensures that the headphones always receive an optimum signal. If necessary, use the **VOLUME** control ⑤ to adjust the volume of the audio signal.

However, the signal of the sound source can be so strong that it can no longer be automatically adjusted.

If the signal of the sound source is too strong, the multi-function LED ② of the transmitter flashes or lights up red.

- ▶ Either adjust the **VOLUME** control ⑤ on the transmitter so that the multi-function LED ② stops flashing or lighting up red.
- ▶ Or adjust the volume of your sound source so that the multi-function LED ② stops flashing or lighting up red.

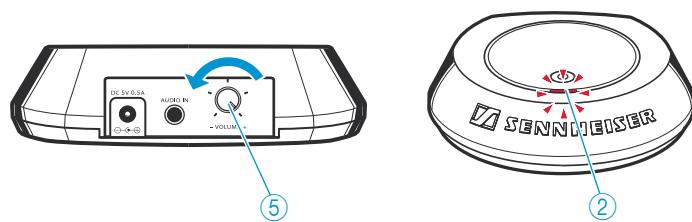

Associating the headphones to the transmitter



The RS 160 system features the digital wireless audio transmission technology from Klear. You can also associate other Klear compatible headphones (e.g. the Sennheiser MX W1) to the transmitter. For more information, refer to the chapter “Associating other Klear compatible headphones to the transmitter” on page 25 or to the instruction manual of the corresponding product.

The headphones and the transmitter are already associated upon delivery. You only have to associate the headphones to the transmitter

- if you want to use another pair of Klear compatible headphones or
- if the transmission between the headphones and the transmitter is disturbed by interferences in the vicinity.

If you want to use several headphones, refer to the chapter “Associating several headphones to the transmitter” on page 25.

Associating the HDR 160 headphones to the transmitter

When associating the headphones to the transmitter, the distance between the transmitter and the headphones should not exceed 1 m.

- ▶ Make sure that the transmitter and the headphones are in standby mode (see page 19 and 20).

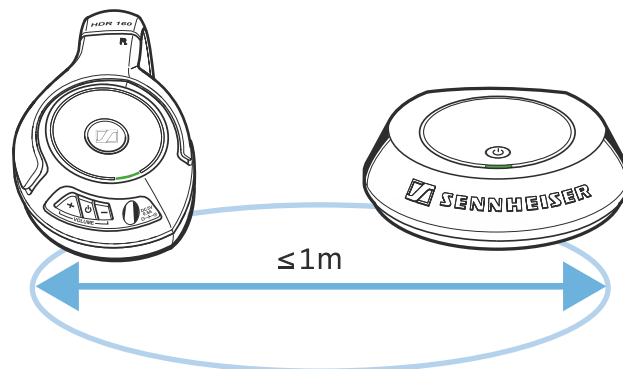



- ▶ Simultaneously press the multi-function button ① of the transmitter and the multi-function button ⑤ of the headphones for 7 seconds.
The multi-function LED ② of the transmitter flashes green.

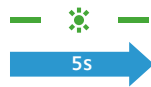
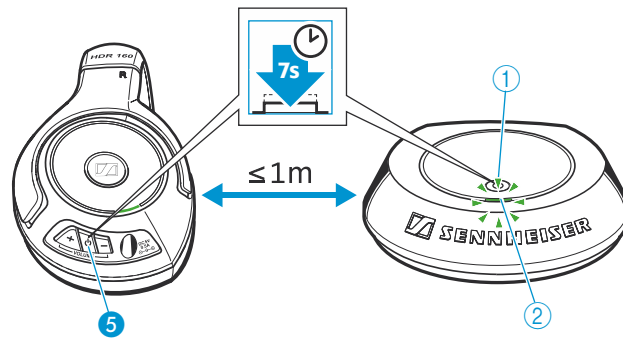

- After approx. 30 seconds, the headphones are paired with the transmitter and you can hear your sound source via the headphones. The multi-function LED ⑧ of the headphones and the multi-function LED ② of the transmitter flash green.

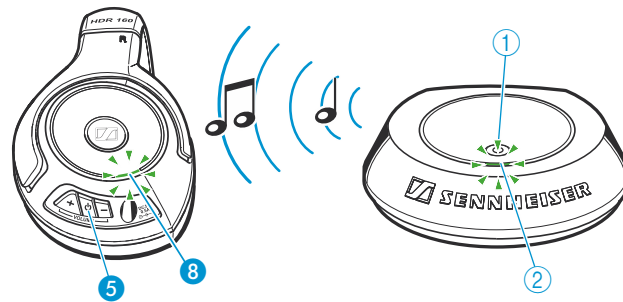

Associating other Kleer compatible headphones to the transmitter

The following describes how to associate the Sennheiser MX W1 earphones to the TR 160 transmitter.

For information on how to associate other Kleer compatible headphones to the transmitter, refer to the instruction manual of the corresponding product.

- ▶ Press the **operation/pairing** button on both MX W1 earphones for 7 seconds.
- ▶ Press the multi-function button **⏻ ①** of the transmitter for 7 seconds.

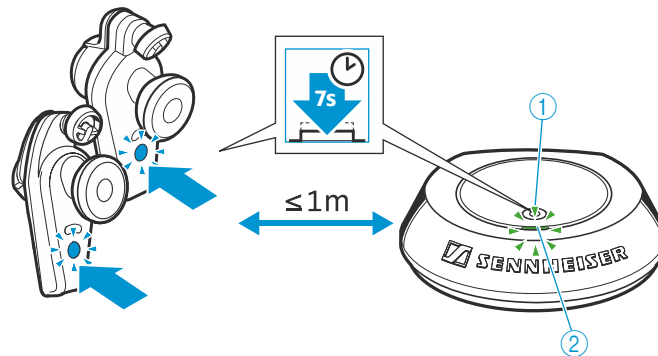

After approx. 30 seconds, the MX W1 earphones are paired with the transmitter and you can hear your sound source via the earphones. The multi-function LED **②** of the transmitter flashes green.

Associating several headphones to the transmitter

In order to be able to use several headphones simultaneously, you first have to associate your additional headphones to the transmitter.

Follow the steps in the previous chapter "Associating the headphones to the transmitter" on page 23.



You can then only use the last headphones paired to listen to your sound source (single-user operation).

To listen to your sound source with up to 4 headphones simultaneously:

- ▶ Set your transmitter to multi-user operation as described in the next chapter.

Listening with several headphones simultaneously

By default, the transmitter is set to single-user operation. In order to be able to listen to your sound source with several headphones simultaneously, you have to set your transmitter to multi-user operation.

- ▶ Make sure that all headphones are paired to the transmitter (see previous chapter).
- ▶ Switch all headphones on (see page 20).
- ▶ Then switch the transmitter on (see page 18).
- ▶ Briefly press the multi-function button  ① of the transmitter. The multi-function LED  of the transmitter and the multi-function LEDs  of the headphones flash green. You can now listen to your sound source with several headphones simultaneously.

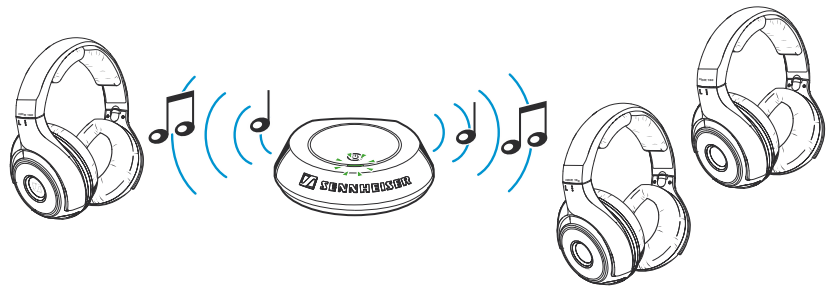

When pressing the transmitter's multi-function button  ① in multi-user operation, the transmitter switches to single-user operation. You can still listen to your sound source with the last headphones paired, the other headphones are disconnected from the transmitter.

Cleaning the RS 160

CAUTION Liquids can damage the electronics of the product!

Liquids entering the housing of the product can cause a short-circuit and damage the electronics.

- ▶ Keep all liquids far away from the product.
 - ▶ Do not use any cleansing agents or solvents.
-

- ▶ Before cleaning, switch the product off and disconnect the transmitter from the mains.
- ▶ Only use a dry and soft cloth to clean the product.

Replacing the ear pads

For reasons of hygiene, you should replace the earpads from time to time. Spare earpads are available from your Sennheiser dealer (see "Accessoires and spare parts" on page 30).

- ▶ Remove the ear pads ② from the ear cups by turning the ear pads in the direction of the arrow until you overcome a slight resistance.
- ▶ Lift the ear pads ② off the ear cups.

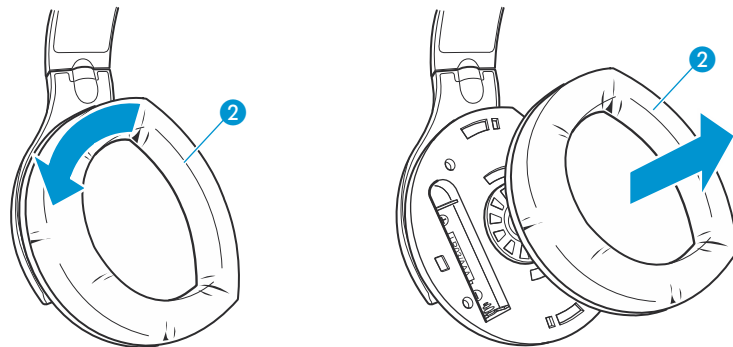

- ▶ Secure the new ear pads to the ear cups.

If a problem occurs ...

Sound problems

Problem	Possible cause	Possible solutions	Page	
No sound	Transmitter is/headphones are switched off	Switch the transmitter/headphones on	18/20	
	Headphones are muted	Cancel the muting	12	
	Jack plug is not properly connected	Check the plug connection	12	
	Sound source is switched off	Switch the sound source on	–	
	Audio cable is defective	Replace the cable	–	
	Transmission between transmitter and headphones is disturbed by interferences (including ESD) in the vicinity	Associate the headphones with the transmitter again		23
		Disconnect the transmitter from the mains and reconnect it again		13
		Remove the rechargeable batteries and reinsert them again		15
Headphones are not correctly associated with the transmitter (e.g. additional headphones)	Associate the headphones with the transmitter		23	
Occasional sound dropouts	Headphones are out of range	Reduce the distance between headphones and transmitter	12	
	Signal is shielded	Remove obstacles between transmitter and headphones	12	
	Interfering devices in the vicinity	Change your position	12	
Sound is too low	Volume of the sound source is adjusted too low	Increase the volume of the sound source	–	
	Signal of the sound source is too weak	Turn the VOLUME control ⑤ on the transmitter clockwise	21	
	Headphone volume is adjusted too low	Increase the volume by pressing the VOLUME + button ④	21	

Problem	Possible cause	Possible solutions	Page
Sound only on one ear	Audio cable is defective	Replace the audio cable	–
	Audio cable is not properly connected	Check the plug connection	12
Sound is distorted	Signal of the sound source is distorted	Reduce the volume of the sound source	–
		Reduce the volume by pressing the VOLUME – button 6 on the headphones	21
Multi-function LED 2 on the transmitter flashes or lights up red	Signal of the sound source is too strong	Turn the VOLUME control 5 on the transmitter counter-clockwise	22
		Reduce the volume of the sound source	22

Other problems

Problem	Possible cause	Possible solution	Page
The transmitter cannot be switched on	No mains connection	Check the connection of the power supply unit to the transmitter and to the mains	13
Headphones cannot be switched on	Rechargeable batteries are flat	Recharge the rechargeable batteries	16
	Rechargeable batteries are inserted the wrong way round	Remove the rechargeable batteries and reinsert them again. Observe correct polarity	15
Operating time decreases	Rechargeable batteries are exhausted	Replace the rechargeable batteries	14/15

If a problem occurs that is not listed in the above table or if the problem cannot be solved with the proposed solutions, please contact your local Sennheiser partner for assistance.

To find a Sennheiser partner in your country, search at www.sennheiser.com.

Accessories and spare part

Only use original Sennheiser accessories and spare parts, otherwise the product quality can be impaired or the product can be damaged.

Cat. No.	Accessory/spare part
504250	HDR 160 headphones
534480	Power supply unit with country adapters
534486	Stereo audio cable with two 3.5 mm jack plugs (2 m)
534479	DC cable (4.0 mm DC jack socket to 2 x 4.0 mm DC plug)
093778	Adapter (3.5 mm jack socket to ¼" (6.3 mm) jack plug)
514267	Adapter (3.5 mm jack socket to 2 RCA plugs)
534470	1 pair of ear pads (closed type)

Specifications

RS 160 system

Modulation	MSK digital
Carrier frequencies	2.4 – 2.48 GHz
Range	approx. 20 m in the open area
Ambient temperature	32 °F to 104 °F (0 °C to 40 °C)

TR 160 transmitter

Audio connection	3.5 mm stereo jack socket
Power consumption (standby mode)	< 0.3 W
Power supply	5 V $\overline{\text{DC}}$, 500 mA 2 AA size batteries, 1.5 V or 2 AA size NiMH rechargeable batteries, 1.2 V, at least 1,300 mAh
Transmission power	< 2.5 mW
Operating time with batteries	approx. 120 hours
Weight (w/o batteries)	approx. 56 g
Dimensions	8.7 cm x 9.7 cm x 2.7 cm

HDR 160 headphones

Transducer principle	circumaural, closed
Max. SPL	106 dB (SPL)
THD	< 0.5 % at 1 kHz, 100 dB SPL
Frequency response	18 Hz – 21,000 Hz
Charging time of rechargeable batteries	approx. 16 hours
Power supply	2 AAA size NiMH rechargeable batteries, 1.2 V, 600 mAh
Operating time	approx. 24 hours
Weight (w/o rechargeable batteries)	approx. 226 g

SSA-4P 5050F power supply unit

Rated input	100 – 240 V \sim , 0.2 A, 50 – 60 Hz
Rated output	5 V $\overline{\text{DC}}$, 500 mA
Operating temperature range	32 °F to 104 °F (0 °C to 40 °C)

Manufacturer declarations

Warranty

Sennheiser GmbH & Co. KG gives a warranty of 24 months on this product. For the current warranty conditions, please visit our website at www.sennheiser.com or contact your Sennheiser partner.

In compliance with the following requirements

- RoHS Directive (2002/95/EC)
- WEEE Directive (2002/96/EC)
- Battery Directive (2006/66/EC)

CE Declaration of Conformity

- R&TTE Directive (1999/5/EC)
- EMC Directive (2004/108/EC)
- Low Voltage Directive (2006/95/EC)

The declaration is available at www.sennheiser.com.

Before putting the product into operation, please observe the respective country-specific regulations!

Rechargeable batteries



The supplied rechargeable batteries can be recycled.

Please dispose of them as special waste or return them to your specialist dealer. In order to protect the environment, only dispose of exhausted batteries.

WEEE Declaration



Your Sennheiser product was developed and manufactured with high-quality materials and components which can be recycled and/or reused. This symbol indicates that electrical and electronic equipment must be disposed of separately from normal waste at the end of its operational lifetime.

Please dispose of this product by taking it to your local collection point or recycling centre for such equipment. This will help to protect the environment in which we all live.

Statements regarding FCC and Industry Canada

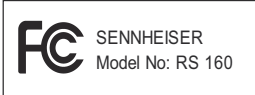
FCC Declaration of Conformity (DoC)	
	
We,	Sennheiser Electronic Corporation Strat. Marketing • Stefanie Reichert One Enterprise Drive • Old Lyme • CT 06371 • USA Tel: +1 (860) 434 9190, ext. 144 Fax: +1 (860) 434 1759
declare the above device comply with the requirements of Federal Communications Commission.	
This device complies with Part 15 of the FCC rules. Operation is subjected to the following two conditions:	
1) This device may not cause harmful interference, and 2) This device must accept any interference received, including interference that may cause undesired operation.	
Responsible Party: John Falcone	

This device complies with Part 15 of the FCC Rules and with RSS-210 of Industry Canada. Operation is subject to the following two conditions: (1) this device may not cause harmful interference, and (2) this device must accept any interference received, including interference that may cause undesired operation.

This equipment has been tested and found to comply with the limits for a Class B digital device, pursuant to Part 15 of the FCC Rules. These limits are designed to provide reasonable protection against harmful interference in a residential installation. This equipment generates, uses and can radiate radio frequency energy and, if not installed and used in accordance with the instructions, may cause harmful interference to radio communications. However, there is no guarantee that interference will not occur in a particular installation. If this equipment does cause harmful interference to radio or television reception, which can be determined by turning the equipment off and on, the user is encouraged to try to correct the interference by one or more of the following measures:

- Reorient or relocate the receiving antenna.
- Increase the separation between the equipment and receiver.
- Connect the equipment into an outlet on a circuit different from that to which the receiver is connected.
- Consult the dealer or an experienced radio/TV technician for help.



This class B digital apparatus complies with the Canadian ICES-003.

Changes or modifications made to this equipment not expressly approved by Sennheiser electronic Corp. may void the FCC authorization to operate this equipment.

RF Radiation Exposure Information

Since the radiated output power of this device is far below the FCC radio frequency exposure limits, it is not subjected to routine RF exposure evaluation as per Section 2.1093 of the FCC rules.

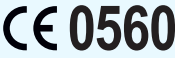
In compliance with:

USA	FCC ID: DMOTR160 FCC ID: DMOHDR160	
Canada	IC: 2099A-TR160 IC: 2099A-HDR160	
Europe		
Australia/ New Zealand		
Singapore	Complies with IDA Standards DB100582	

Trademarks

The Kleer logo is a trademark of Kleer Inc.

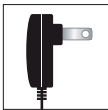

Powered by an
ENERGY STAR®
qualified adapter
for a better
environment

About ENERGY STAR

ENERGY STAR is a joint program of the U.S. Environmental Protection Agency and the U.S. Department of Energy helping us all save money and protect the environment.



Sennheiser electronic GmbH & Co. KG
Am Labor 1, 30900 Wedemark, Germany
www.sennheiser.com

Publ. 08/09
A01